

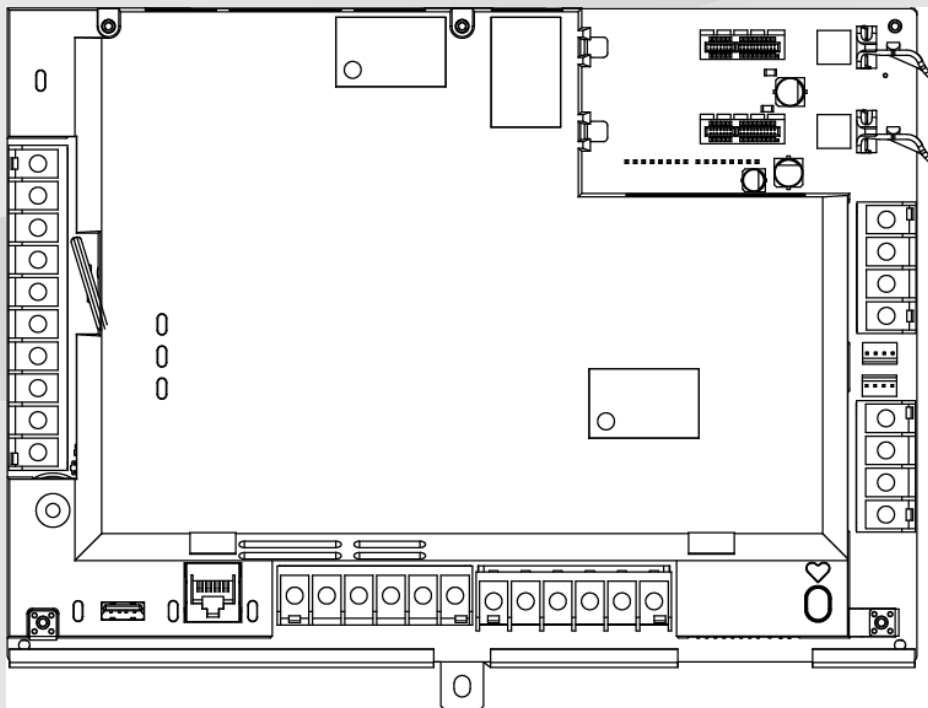

BOSCH

Control panels

B9512G/B8512G (B9512G-E/B8512G-E)



en

UL Installation manual

1 Introduction

This section includes an introduction to documents for this product and other document-related instructions.

1.1 About documentation

This document has instructions for a trained installer to install, configure, and operate this control panel, and optional peripheral devices.

(Bosch Security Systems, Inc. recommends that installers follow good wiring practices such as those described in NFPA 731, Standard for the Installation of Electronics Premises Security Systems.)

Throughout this document, the words “control panel” refer to all control panels covered by this document (B9512G/B8512G/B9512G-E/B8512G-E).

Notifications

This document uses Notices, Cautions, and Warnings to draw your attention to important information.



Notice!

These include important notes for successful operation and programming of equipment, or indicate a risk of damage to the equipment or environment.



Caution!

These indicate a hazardous situation which, if not avoided, could result in minor or moderate injury.



Warning!

These indicate a hazardous situation which, if not avoided, could result in death or serious injury.

Copyright

This document is the intellectual property of Bosch Security Systems, Inc. and is protected by copyright. All rights reserved.

Trademarks

All hardware and software product names used in this document are likely to be registered trademarks and must be treated accordingly.

1.1.1 Related documentation

Control panel documents

<i>Control Panels (B9512G/B8512G) Release Notes*</i>
<i>Control Panels (B9512G/B8512G) Installation Manual*</i>
<i>Control Panels (B9512G/B8512G/B6512/B5512/B4512/B3512) Operation Manual* +</i>
<i>Control Panels (B9512G/B8512G) Program Entry Guide*</i>
<i>Control Panels (B9512G/B8512G) UL Installation Manual* +</i>
<i>Control Panels (B9512G/B8512G) SIA Quick Reference Guide* +</i>

<i>Control Panels (B9512G/B8512G/B6512/B5512/B4512/B3512) ULC Installation Manual</i>

*Shipped with the control panel.

*Located on the documentation CD shipped with the control panel.
--

Keypad documents

<i>Basic Keypad (B915) Installation Guide*</i>
--

<i>Two-line Alphanumeric Keypad (B920) Installation Guide*</i>
--

<i>Fire Keypads (B925F/B926F) Installation Guide*</i>

<i>Two-line Capacitive Keypad with Inputs (B921C) Installation Guide*</i>

<i>ATM Style Alphanumeric Keypad (B930) Installation Guide*</i>

<i>B940W Touch screen KP, White Quick installation guide*</i>

<i>Touch Screen Keypad (B942/B942W) Installation Guide*</i>

*Shipped with the keypad.

Optional module documents

<i>Octo-input Module (B208) Installation and Operation Guide*</i>

<i>POPEX Module (B299) Installation Guide*</i>
--

<i>Octo-output Module (B308) Installation and Operation Guide*</i>
--

<i>Conettix Ethernet Communication Module (B426) Installation and Operation Guide* +</i>
--

<i>Plug-in Telephone Communicator (B430) Installation Guide Installation Guide*</i>

<i>Conettix Plug-in GPRS Cellular Communicator (B442) Installation and Operation Guide*</i>

<i>Conettix Plug-in HSPA+ Cellular Communicator (B443) Installation and Operation Guide*</i>
--

<i>Conettix Cellular Communicators B44x Installation Manual</i>

<i>Conettix Plug-in cellular module VZW LTE B444/B444-C Installation Manual*</i>
--

<i>B444-A B444-V Quick installation guide*</i>
--

<i>Conettix Plug-in Communicator Interface (B450) Installation and Operation Guide* +</i>

<i>Auxiliary Power Supply (B520) Installation and Operation Guide*</i>
--

<i>Retrofit ZONEX Module (B600) Installation Guide</i>
--

<i>RADION receiver SD (B810) Installation Guide*</i>
--

<i>SDI2 Inovonics Interface Module (B820) Installation Guide*</i>

<i>Access Control Module (B901) Installation Guide</i>
--

<i>Dual Class B Initiating Module (D125B) Installation Instructions</i>

<i>Multiplex Bus Interface (D8125MUX) Operation and Installation Guide</i>
--

<i>OctoPOPIT Module (D8128D) Installation Guide</i>

<i>Access Control Interface Module (D9210C) Installation and Operation Guide</i>
--

*Shipped with the module.

[†]Located on the documentation CD shipped with the module.

1.2 **Bosch Security Systems, Inc. product manufacturing dates**

Use the serial number located on the product label and refer to the Bosch Security Systems, Inc. website at <http://www.boschsecurity.com/datecodes/>.

2 System overview

This section has the following information:

- *Parts list, page 6*
- *Control panel capacities, page 6*
- Accessories
- Features

2.1 Parts list

Control panels ship assembled from the factory with the following parts:

Literature

- *Control Panels (B9512G/B8512G) UL Installation Manual*
- *Control Panels (B9512G/B8512G/B5512/B4512/B3512) Operation Manual*
- *Control Panels (B9512G/B8512G) SIA Quick Reference Guide*
- *Control Panels (B9512G/B8512G) Documentation CD*
- *Product Label in French*
- *7000/9000 Series Point Chart Label*

HW pack

- 1 kΩ EOL resistors
- Battery wires

Assembly

- PC board with protective cover
- Mounting skirt
- One #6 x 3/4-inch screw

2.2 Control panel capacities

Features	B9512G/ B9512G-E	B8512G/ B8512G-E
Number of users	2000	500
Total number of doors	32 ¹	8 ¹
Number of cards/tokens	2000	500
Number of custom functions	32	8
Number of areas	32	8
Number of points	599	99
Number of outputs	599	99
Total number of keypads	32 ²	16 ²
Number of octo-input modules (B208)	59	9
Number of POPEX modules (B299)	6	1
Number of octo-output modules (B308)	59	9
Number of on-board Ethernet ports ("E" control panel variants do not include an Ethernet port)	1	1
Number of B426 or B450 modules	2	2
Number of plug-in telephone communication modules (B430)	2	2

Features	B9512G/ B9512G-E	B8512G/ B8512G-E
Number of plug-in cellular modules (B440/B441/B442/B443/B444/B444-A/B444-V)	1	1
Number of auxiliary power supply modules (B520)	8	4
Number of wireless receivers (B810/B820)	1	1
Number of cameras ³	16	8
<p>¹The control panel supports 32 doors using the optional B901 Access Control Module. The control panel supports up to 8 doors using the optional D9210C Access Control Interface Module.</p> <p>²The control panel supports up to 16 of the keypads as SDI keypads.</p> <p>³Bosch IP cameras use is supplementary in UL Listed systems.</p>		

3 Control panel installation

Refer to Enclosures to determine if the application requires a specific enclosure.

Enclosure and control panel (back view) overview

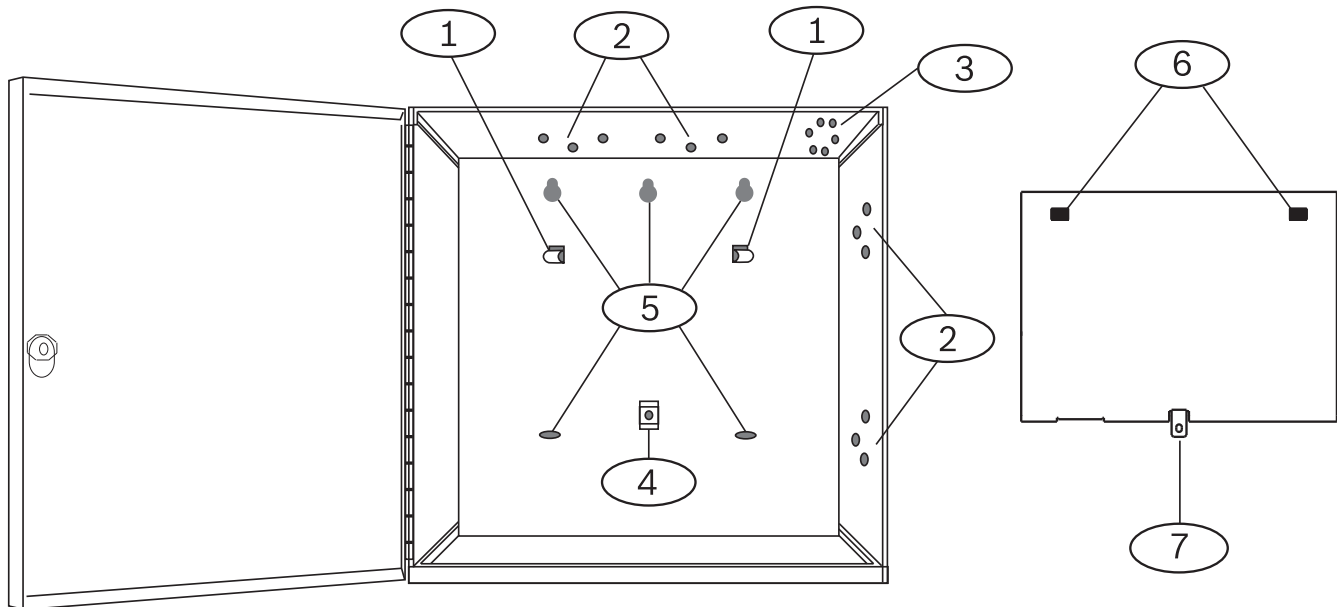

Callout — Description	Callout — Description
1 — Hooks to attach the mounting skirt (2)	5 — Enclosure mounting holes (5)
2 — Three-hole pattern for mounting modules (4)	6 — Holes to attach the mounting skirt to hooks (2)
3 — Mounting location for the tamper switch	7 — Tab to secure the mounting skirt
4 — Mounting skirt screw location	

3.1 Installing the enclosure



Notice!

Electromagnetic interference (EMI)

EMI can cause problems on long wire runs.

1. Remove the knockouts.
2. Mount the enclosure. Use all enclosure mounting holes. Refer to the mounting instructions supplied with the selected enclosure.
3. Pull the wires into the enclosure through the knockouts.
4. Position the supplied point label chart on the inside of the enclosure door (optional).

3.2 Installing the control panel

1. Position the control panel over the inside back of the enclosure.
2. Align the Holes to attach the mounting skirt to hooks with the hooks.
3. Slide the control panel down so that it hangs on the hooks.
4. Secure the mounting skirt.

3.2.1

Earth ground

To help prevent damage from electrostatic discharges or other transient electrical surges, connect the system to earth ground before making other connections. The earth ground icon identifies the earth ground terminal. Recommended earth ground references are a grounding rod or a cold water pipe. Make the connection using 14 AWG (1.8 mm) to 16 AWG (1.5 mm) wire.

To help prevent damage from electrostatic discharges or other transient electrical surges, connect the system to earth ground before making other connections. The \perp icon shows the earth ground terminal. Use a recommended earth ground reference, such as a grounding rod or a cold water pipe. Make the connection using 14 AWG (1.8 mm) to 16 AWG (1.5 mm) wire.



Notice!

Do not use telephone or electrical ground

Do not use telephone or electrical ground for the earth ground connection. Do not connect other control panel terminals to earth ground.



Caution!

Avoid electrostatic discharge

Always touch the earth ground connection with the \perp icon first, before beginning work on the control panel.

3.2.2

Ground Fault Detect enable

To meet UL 864 requirements, enable Ground Fault Detect.

A ground fault is a circuit impedance to ground sufficient to result in the annunciation of a trouble condition.

The control panel has a ground fault detection circuit that when enabled, detects ground faults on Terminals 1 to 9 and 11 to 30.

If a ground fault condition occurs, the keypads annunciate a ground fault and control panel transmits a trouble message.

When the control panel recognizes that the ground fault condition is corrected, and remains corrected for between 5 to 45 consecutive seconds, the control panel clears the fault from the keypad display and sends a restoral report.

The control panel detects ground fault at $\leq 300 \Omega$.

Enabling Ground Fault Detect and reports

- ▶ In RPS or in the Installer Services Portal programming tool (available in Europe, Middle East, Africa, and China), set the following parameters:
 - PANEL WIDE PARAMETERS > Miscellaneous > Ground Fault Detection. Set to Enable.
 - PANEL WIDE PARAMETERS > Report Routing > Burglar Reports > Trouble Report. Set to Yes.
 - PANEL WIDE PARAMETERS > Report Routing > Burglar Reports > Burg Restore (After Trouble). Set to Yes.

3.2.3

Ground fault detection troubleshooting

The control panel requires -2.1 V decay to 0.

Measuring and comparing voltage for ground fault detection

1. Set your digital voltmeter (DVM) to measure VDC.
2. Connect the red DVM lead to control panel Terminal 10, and the black DVM lead to Terminal 9.
3. Compare this voltage to the following table.

Control panel voltage at Terminals 9 and 10)	Terminal potentially causing ground fault
~ 0 VDC	4, 9, 12, 15, 17, 21
~ 13.65 VDC	5, 6, 7, 8, 26, 30
~ 2.51 VDC	11, 13, 14, 16, 17, 19, 20, 22
~ 2.44 to 3.2 VDC	24
~ 10.9 to 11.2 VDC	25
~ 7.2 VDC	28
~ 5.8VDC	29
~ 7.35 VDC	1, 2

3.3 Control panel to module wiring overview

You can use interconnect or terminal wiring to connect devices to the control panel. If SDIx is configured for SDI2, use either SDI2 bus.

Using terminal wiring in parallel



Notice!

Wire size

For terminal wiring, use 18 AWG to 22 AWG (1.0 mm to 0.6 mm) wire.

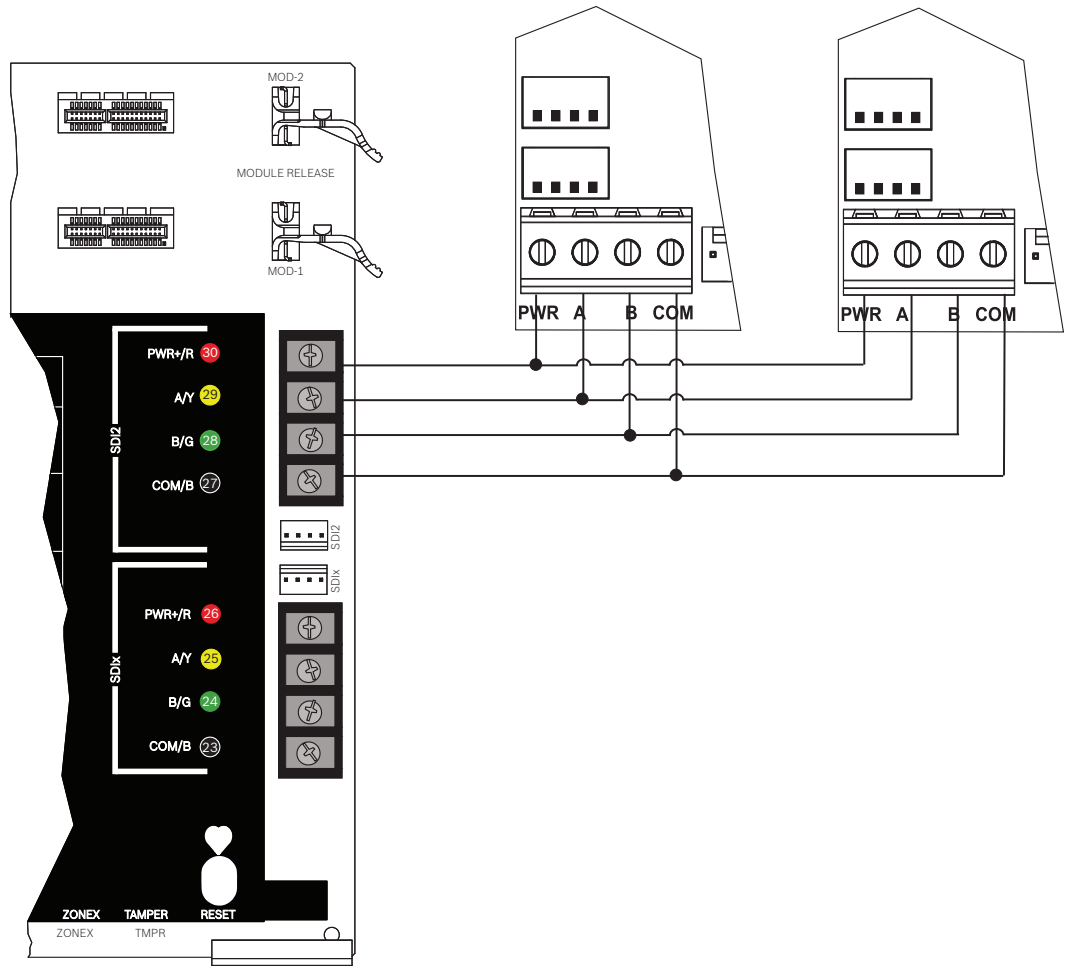

Using interconnect wiring



Notice!

More information

For more information on interconnect wiring, refer to SDI2 interconnect wiring.

SDI2 devices daisy chained with interconnect wiring

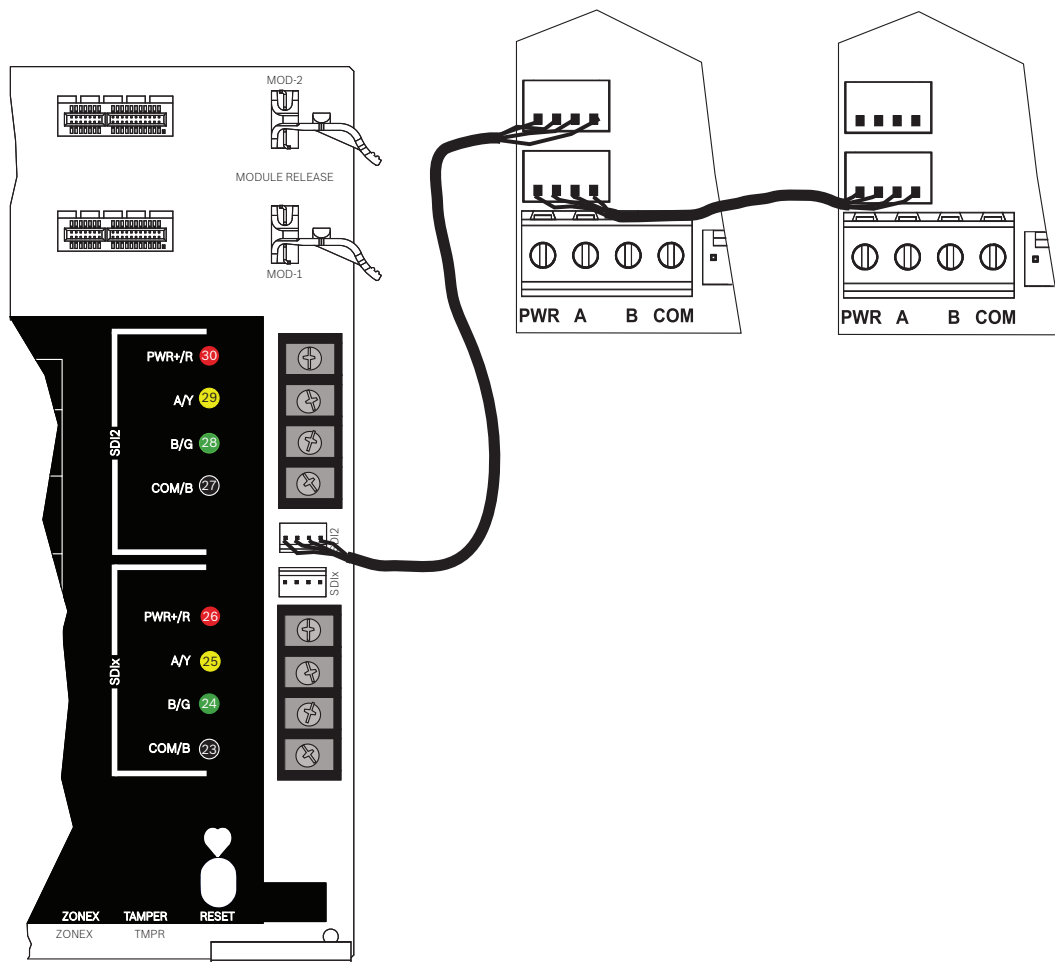

4 Power supply

This section provides information on installing and maintaining primary power, batteries, and auxiliary power.

4.1 Secondary (DC) power

4**5**

A 12 V sealed lead-acid rechargeable battery (such as the D126/D1218) supplies secondary power to maintain system operation during interruptions of primary (AC) power.

**Notice!****Use sealed lead acid batteries only**

The charging circuit is calibrated for lead-acid batteries. Do not use gel-cell or NiCad batteries.

Extra batteries

To increase battery back-up time, connect a second 12 V battery in parallel to the first battery. Use a D122/D122L Dual Battery Harness to ensure proper and safe connection. Refer to Standby battery requirements and calculations.

D1218 Battery

The D1218 is a 12 V, 18 Ah battery for use in applications requiring extended battery standby time. The control panel does not support more than 38 Ah of battery.

4.1.1 Install the battery

1. Put the battery upright in the base of the enclosure.
2. Locate the red and black leads supplied in the hardware pack.
3. Connect the black battery lead to 4 .
4. Connect the other end to the negative (-) side of the battery.
5. Connect the red battery lead to 5.
6. Connect the other end to the positive (+) side of the battery.

**Warning!****High current arcs are possible**

The positive (red) battery lead and the terminal labeled 5 can create high current arcs if shorted to other terminals or the enclosure. Use caution when you touch the positive lead and the terminal labeled 5. Always disconnect the positive (red) lead from the battery before you remove it from the terminal labeled 5.

**Caution!****Battery terminals and wire are not power limited**

Maintain a 0.250 in (6.4 mm) space between the battery terminals, battery wiring, and all other wiring. Battery wiring cannot share the same conduit, conduit fittings, or conduit knockouts with other wiring.

Non-power-limited wiring

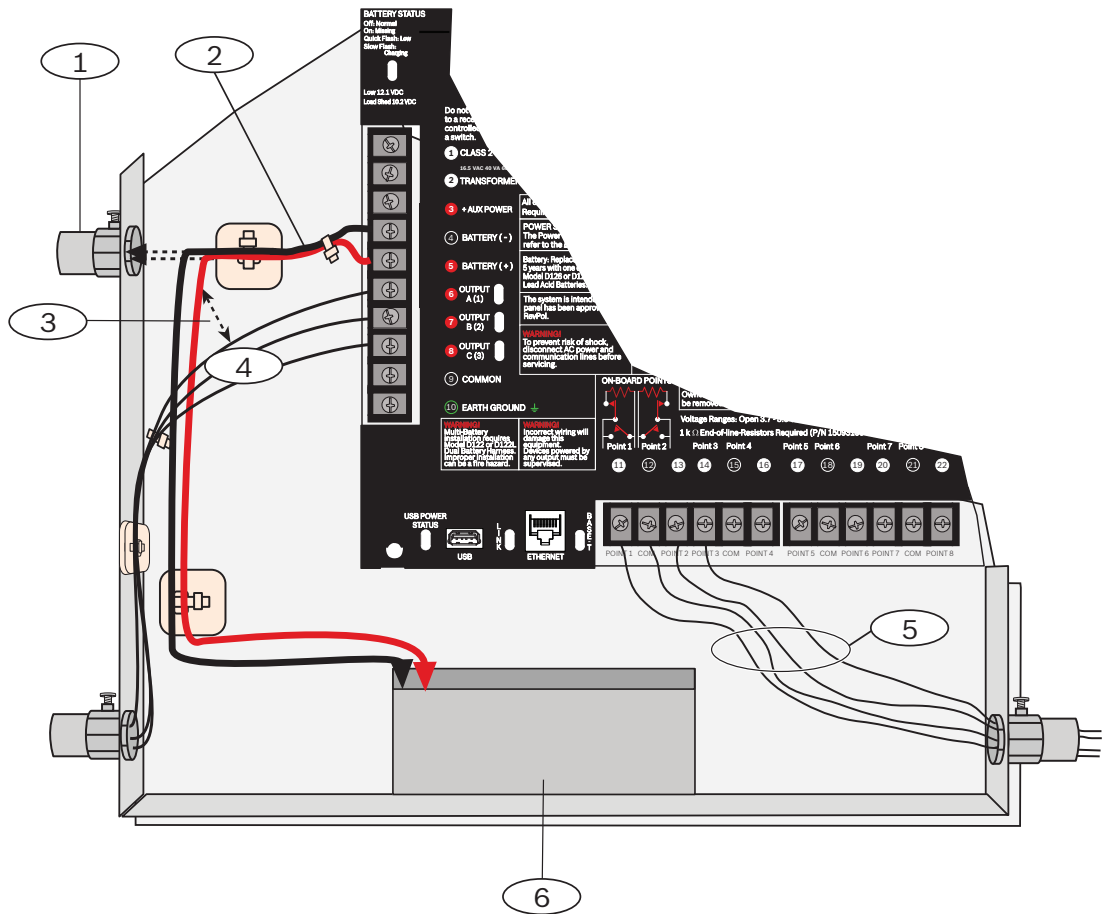

Callout — Description
1 — Conduit required for use with external batteries
2 — Battery wires
3 — 0.25 in (6.4 mm) minimum. To ensure proper spacing, use tie-wraps or similar devices to secure wires.
4 — Output wires
5 — Sensor loop wires
6 — 12 V sealed lead-acid rechargeable battery (D126/D1218)





Charging the battery

1. Connect the battery
2. Connect the transformer.
3. Allow the control panel to charge the battery while you complete the installation.

4.1.2

BATTERY STATUS LED

The control panel includes one BATTERY STATUS LED with 4 LED patterns to indicate the battery status.

LED pattern	Function	Refer to
 Off	Battery is fully charged.	N/A
 Flashing slowly	Battery charge is below 13.4 VDC and the battery is recharging.	<i>Low battery, page 15 and Battery restoral, page 15</i>
 Flashing quickly	Battery voltage dropped to between 12.1 VDC and 10.2 VDC. LED turns off when voltage reaches at least 13.4 and > 200 mA.	<i>Low battery, page 15 and Battery restoral, page 15</i>
 On Steady	Battery is missing, shorted, or reversed.	<i>Missing battery, page 15</i>

4.1.3

Battery maintenance

Use 12 VDC sealed lead-acid rechargeable battery (7 Ah, 18 Ah, or 38 Ah). The control panel supports up to 38 Ah of battery. If you use two batteries, they must have the same capacity, and you use a D22/D122L to connect them.

Replace the batteries every 3 to 5 years. If you install two batteries, replace them both at the same time.

Record the date of installation directly on the battery.



Caution!

Heavy discharges possible

The system can have heavy discharges if you exceed the maximum output ratings or install the transformer in an outlet that is routinely switched off. Routine heavy discharges can lead to premature battery failure.

4.1.4

Battery supervision

Low battery

If the control panel is programmed for power supervision, it sends a Battery Low report in the Conettix Modem4 format or a Low System Battery (302) report in the Conettix ANSI-SIA Contact ID format.

Missing battery

If the control panel is programmed for power supervision, it sends a Battery Missing/Dead report in the Conettix Modem4 format, or a Control Panel Battery Missing (311) report in the Conettix ANSI-SIA Contact ID format.

Battery restoral

When AC returns and the battery is charged, If the control panel is programmed for power supervision, it sends a Low System Battery Restore report in the Conettix Modem4 format or a Control Panel Battery Restored to Normal (302) report in the Conettix ANSI-SIA Contact ID format.

4.1.5 Battery charging circuit float charge

The float voltage for the battery charging circuit is 13.65 VDC when operating within load range.

Load shed

Load shed relay protects battery: During an AC power loss, the battery supplies all power to the security system. If the battery voltage falls below 10.0 V during an AC power loss, a load shed relay disconnects the battery from the control panel and disables control panel. Load shed protects the battery from being damaged by deep discharge.

When AC power restores, the load shed relay reconnects the charging circuit on control panel to the battery and the battery begins to recharge.

Over load with AC present

If devices draw more than 1.6 A of auxiliary current from the control panel with AC applied, the control panel indicates a Panel Over-current system trouble. Unless corrected, this condition prevents the control panel from properly maintaining the battery charge level, and leaves the system vulnerable to failing during power outages.

To correct the issue, remove all loads to the control panel and disconnect the battery and AC power. Fix the condition creating the over current and reconnect AC power.

A shorted battery condition (created either by a shorted cell inside the battery or by a short on Terminals 4 and 5), might prevent the control panel from operating, or might cause the control panel to detect a missing battery condition.



Caution!

Shorting the battery terminals is dangerous.

4.1.6 Battery discharge and recharge schedule

Battery discharge/recharge schedule	Discharge Cycle	13.30 VDC 12.1 VDC 10.2 VDC 10.2 VDC	BATTERY STATUS LED slow flash. Low Battery Report, if programmed. BATTERY STATUS LED quick flash. Minimum operational voltage. Battery load shed.
	Recharge Cycle	AC ON 12.50 VDC (under load) 13.4 VDC and charging current < 200 mA	Load shed relay resets, battery charging begins. Battery Restoral Report sent, BATTERY STATUS LED off. Battery float charged. BATTERY STATUS LED off.

4.2 B520 aux power supply

The optional B520 provides up to 2 A of 12 VDC standby power for Fire and Burglar applications. For Burglar applications, an additional 2 A of alarm power is available, allowing 2 A of standby current and up to 4 A of alarm current.

The control panels support the following number of B520 modules:

- B9512G. 8
- B8512G. 4

The power supply draws approximately 15 mA (+/- 1 mA) from the control panel.

For detailed instructions, refer to the corresponding document listed in *Related documentation, page 3*.

4.2.1 SDI2 address settings



Notice!

The module reads the address switch setting only during module power up. If you change the setting after you apply power to the module, you must cycle the power to the module in order for the new setting to take effect.

If multiple B520 modules reside on the same system, each B520 module must have a unique address.

4.2.2 Supervision

The control panel supervises any B520 on the SDI2 bus.

With any failure to receive an expected response from a B520, all keypads show a system fault. The control panel sends a module trouble report to the central station (if configured for module trouble reports).

4.2.3 Auxiliary power supply trouble conditions

Each auxiliary power supply module on the SDI2 bus monitors several conditions including AC status, battery status, over current status, and a tamper input. Each of these conditions produces a unique system trouble condition at all keypads. The control panel sends a module trouble report to the central station (if configured for module trouble reports).

4.2.4 Installation and control panel wiring (B520)

Calculate power consumption

Make sure that there is enough power for the module and the other powered devices that you want to connect to the system.

Refer to *On-board outputs*, page 21.



Caution!

Remove all power (AC and battery) before making any connections. Failure to do so might result in personal injury and/or equipment damage.

Installing the module

1. Set the module address.
2. Insert the plastic mounting clips onto the standoff locations inside the enclosure or on a mounting skirt, when required.
3. Mount the module onto the plastic mounting clips.
4. Tighten the supplied mounting screws.

Wiring to earth ground

- ▶ To help prevent damage from electrostatic charges or other transient electrical surges, connect the system to earth ground before making other connections.



Notice!

Earth ground reference

Do not use telephone or electrical ground for the earth ground connection. Use 14 AWG (1.8 mm) to 16 AWG (1.5 mm) wire when making the connection

Use a grounding rod or a cold water pipe.

Run wire as close as possible to grounding device.

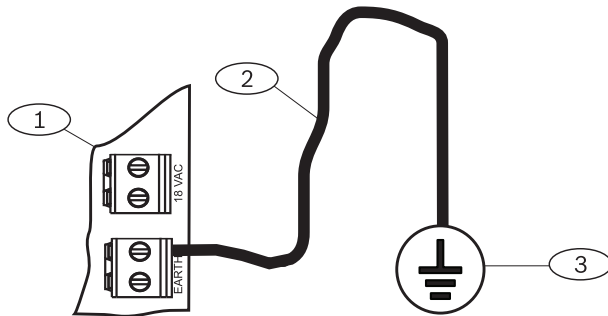

Callout — Description
1 — B520 Auxiliary Power Supply Module
2 — 14 AWG - 16 AWG (1.8 mm - 1.5 mm) wire
3 — Ground device (grounding rod or cold water pipe)

Wiring to the control panel



Notice!

Terminal wiring

Use the terminal strip labeled with PWR, A, B, and COM for SDI2 IN to wire to corresponding control panel SDI2 terminals. Do not use interconnect wiring.

Use 12 AWG to 22 AWG (2.0 mm to 0.6 mm) wire.

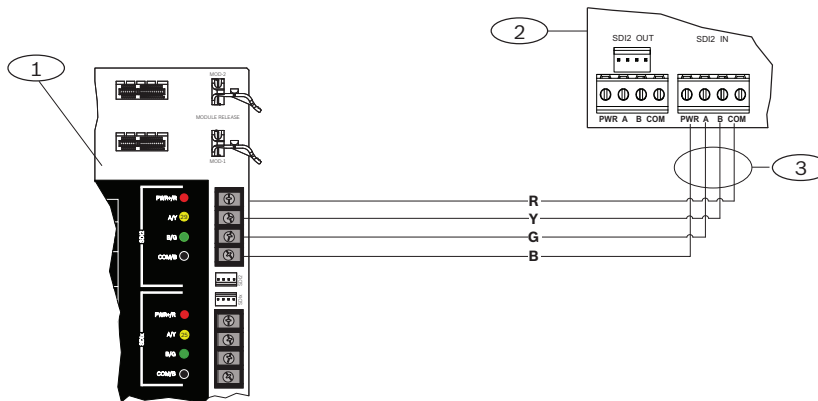

Callout — Description
1 — Control panel
2 — B520 Auxiliary Power Supply Module
3 — Terminal strip wiring

4.2.5

Powered device and battery wiring

When you wire the output of a B520 to a SDI2 module, the B520 provides power to the module while passing through data between the control panel and the module.

Wiring SDI2 modules

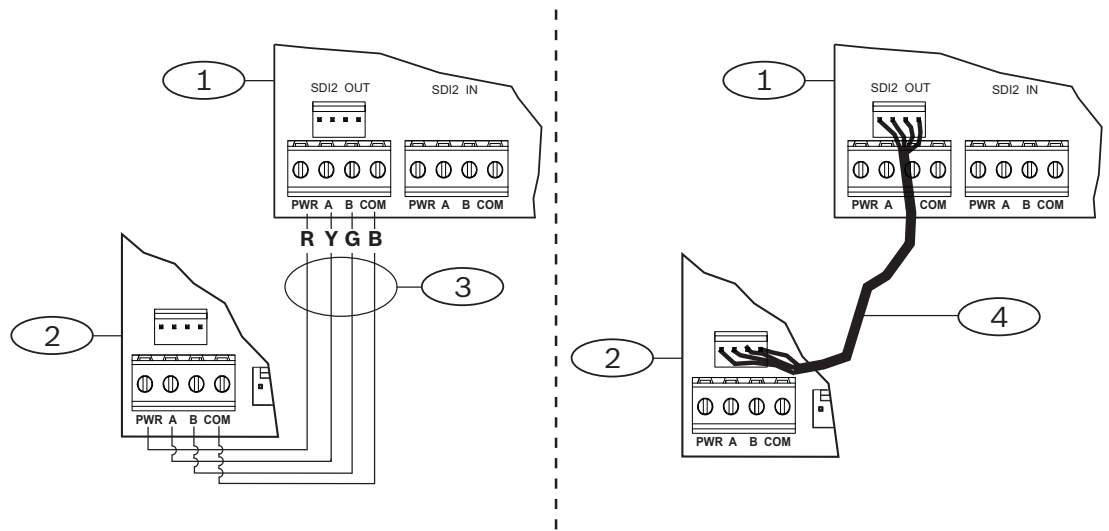

Callout	Description
1	B520 Auxiliary Power Supply Module
2	Powered device (SDI2 module)
3	Terminal strip wiring
4	Interconnect wiring (P/N: F01U079745)

- Do one of the following:
 Use terminal wiring to connect the SDI2 OUT terminal strip labeled with PWR, A, B, and COM on the B520 to the terminals labeled PWR, A, B, and COM on the first module.
 Connect an interconnect wiring cable (included) to the SDI2 OUT interconnect connector on the B520 to the interconnect connector on the first module.
- Connect additional modules in series with the first module.

Wiring to batteries



Notice!

Battery wiring requirements

You must wire BATT 1. You must wire BATT 2 if you configure the B520 for two batteries. When you use BATT 2, both batteries must have the same rating. Maximum standby power cannot exceed 36 Ah.

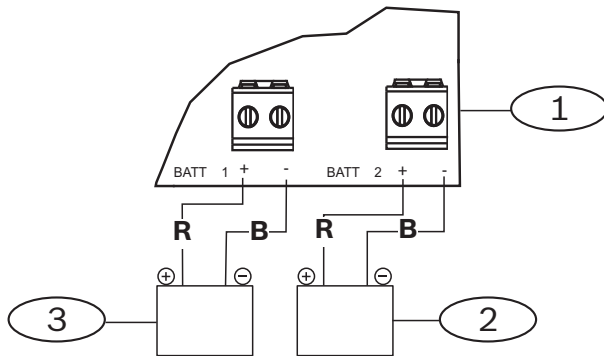

Callout	Description
---------	-------------

1 — B520 Auxiliary Power Supply Module
2 — Battery 2 (BATT 2) - (12 V nominal lead acid)
3 — Battery 1 (BATT 1) - (12 V nominal lead acid)

5 On-board outputs

The control panel provides three powered relay outputs.

5.1 Circuit protection

The powered outputs come with circuit protection.

Four self-resetting circuit breakers protect the control panel from short circuits on the continuous and programmable power outputs. Each breaker protects a separate terminal or group of terminals:

- Terminal 3, auxiliary power
- Power terminals
 - Terminal 6. Alarm power output
 - Terminal 7. Alternate alarm power output
 - Terminal 8. Switched auxiliary power
 - Terminals 26 and 30, power +
 - ZONEX connection

**Notice!**

A short circuit on one terminal disrupts power to the other two terminals.

**Notice!****UL requirement**

Supervise devices powered from a power output.

5.2 Total available power

The system produces up to 1.4 A of combined power at 12.0 VDC nominal. The outputs in this section share the available power. These outputs appear as shown on the faceplate.

3**Auxiliary power**

Power devices requiring continuous power.

6**Output A (1), Alarm power output**

Programmable output normally open, power on alarm.

7**Output B (2), Alternate alarm power output**

Programmable output normally open, power on alarm.

8**Output C (3), Switched auxiliary power**

Programmable output normally closed, switches power off when the Sensor Reset command is executed.

26**SDIx Power+ / R**

Powers serial device interface (SDI) keypads, or use to power serial device interface 2 (SDI2) devices, such as keypads and expansion modules.

30

SDI2 Power+ / R

Powers serial device interface 2 (SDI2) devices, such as keypads and expansion modules.

ZONEX

ZONEX Power

Powers ZONEX modules such as the D8125, D8128D, and D8129 connected through the B600.

5.3**Continuous power outputs**

3

26

30

ZONEX

The continuous current draw for powered devices connected to Terminals 3, 26, and 30, and the ZONEX connector must not exceed 1.4 A. Devices powered from these outputs operate at 12.0 VDC Nominal.

**Notice!****Power Restricted for Fire and Combined Fire and Burglary Systems**

Use the *Fire system power formula*, page 23 to calculate the current available for fire and combined fire and burglary systems

5.4**Programmable power outputs**

6

7

8

The power outputs at Terminals 6, 7, and 8 are programmed as Outputs A (1), B (2), and C (3).

Assign each output an output type (Steady Alarm Bell, for example), when assigning it to an area. You can assign an output to one or more areas.

The defaults are:

- Output A (1) - Terminal 6 - as a Steady Alarm Bell output
- Output B (2) - Terminal 7 - as a Pulsed Fire Bell output
- Output C (3) - Terminal 8 - as a Verification or Reset output for smoke detectors

The Program Entry Guide contains complete instructions for programming outputs. Refer to the Bell Parameters section of the program to set the Fire Bell, Alarm Bell output responses for outputs. Four annunciation patterns are available: Steady, Pulsed, California Standard, and Temporal Code 3.

If Terminals 6, 7, and 8 do not provide the expected output, check:

- The *Outputs* section of the program for Outputs A (1), B (2), and C (3).
- The *Bell Parameters* section of the program to confirm that the Alarm and Fire Bell responses are programmed for the expected duration and pattern.
- The *Point Assignments* section to confirm that each point is programmed for the expected local response.

5.4.1**Terminals 6 and 7**

6

7

When activated, Terminals 6 (Output A) and 7 (Output B), provide a positive (+) 12.0 VDC Nominal power output. Use the power at Terminals 6 and 7 to power bells, siren drivers, piezoelectric sounders, electronic horns, or other devices.

Programming determines the format of the output and the conditions that activate it.

When using Output A or Output B to activate notification appliance circuits in UL Listed fire alarm applications, install a D192G.

Power restricted for Fire and Combined Fire and Burglary Systems

Fire systems are prohibited from using the battery for supplying alarm power. Use the fire system power formula that follows to calculate the current available for fire and combined fire and burglary systems.

Fire system power formula

Calculating the current available at Terminals 6 and 7 for fire and combined fire and burglary systems:

1. Add together the current draws for all devices connected to Terminals 3, 26, and 30, and the ZONEX connector. This is the total current required for the normal standby condition (NSC).
2. The current available for NSC is 1.4 A. Subtract the NSC current required calculated in Step 1 from the NSC current available, 1.4 A. The difference is the alarm current available for Terminals 6 and 7.

In formula format: 1.4 A – NSC current required (Step 1) = Alarm current available

Refer to Approved applications for module or accessory current requirements

5.4.2

Terminal 8



Terminal 8 provides continuous positive (+) 12.0 VDC Nominal power. Output C interrupts the power at Terminal 8 when activated. Use Terminal 8 to power smoke detectors or other devices that reset by interrupting power.

Verify and reset Output C

The default program sets Output C (Terminal 8) as a verification and reset output. Refer to *Output Parameters* and *Point Assignments* in the control panel *Program Entry Guide* for instructions on programming verification and resetting outputs and points.

Performing a sensor reset at a keypad produces a five-second activation of verification and reset outputs. The control panel ignores verification and resettable points during the five seconds.

5.5

USB power



In addition to connecting RPS or the Installer Services Portal programming tool (available in Europe, Middle East, Africa, and China) to the control panel for programming, you can use the USB port on the control panel to power USB-powered devices.

When enabled, the USB port provides 500 mA of 5 V power. The port draws the power from the control panel. Make sure that there is enough power for all the powered devices you want to connect to the system.

Enabling USB power:

- ▶ Do one of the following:
 - Press the control panel RESET button 3 times.
 - Use the keypad Installer menu (refer to [7] USB Power).

The USB POWER STATUS LED lights when power to the USB is turned on.

You can disable USB at any time. Use the Installer menu or press the control panel RESET button 3 times.

6 Control panel board overview

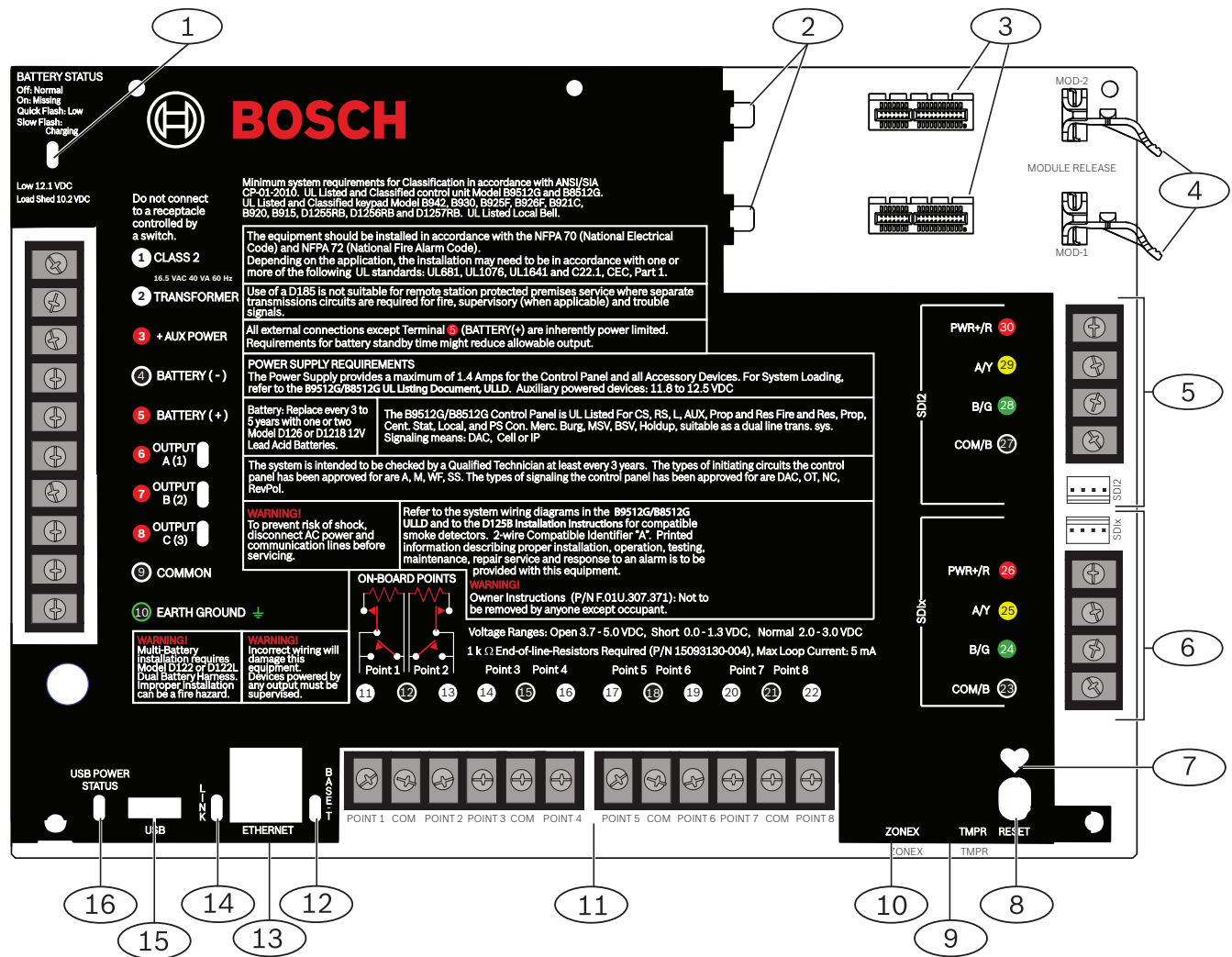

Callout — Description	Callout — Description
1 — BATTERY STATUS LED	9 — Tamper switch connector location
2 — Holes to stabilize plug-in modules	10 — Zonex module connector location
3 — Plug-in module connectors	11 — Sensor loop terminals for points 1 to 8
4 — Plug-in module connector	12 — BASE-T LED (green)
5 — SDI2 wiring	13 — On-board Ethernet connector
6 — SDI1x wiring (use as SDI or SDI2)	14 — LINK LED (yellow)
7 — Heartbeat LED (blue)	15 — USB connector
8 — RESET button	16 — USB POWER STATUS LED

7 System wiring diagrams

**Notice!****UL notifications**

Add additional power using only a UL Listed 12.0 VDC regulated, power-limited power supply such as the B520.

All terminals except Outputs A (1), B (2), and C (3) (Terminals 6, 7, and 8) are supervised. For proper supervision, do not loop wire under terminals. Break the wire run to provide supervision of connections.

7.1 Power supply side wiring

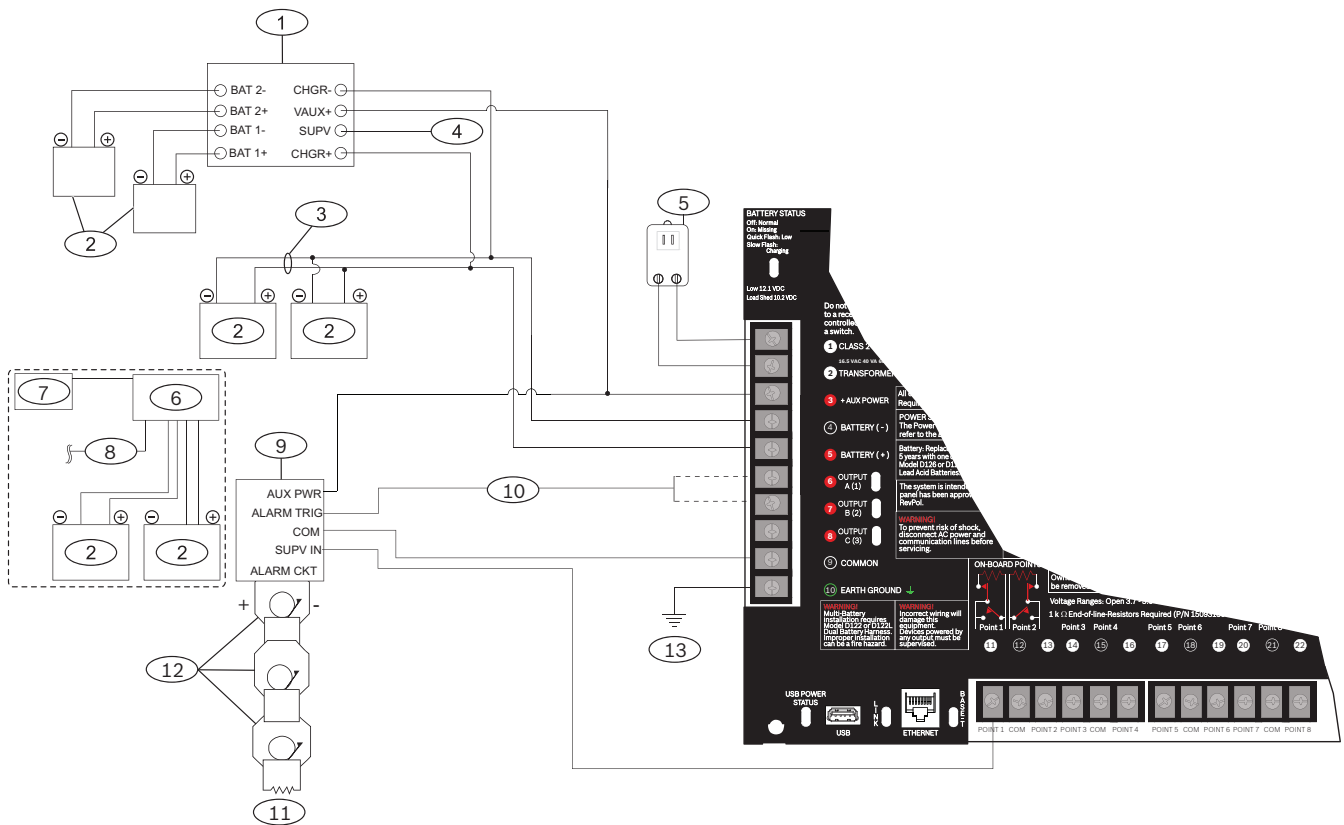

Callout — Description	Callout — Description
1 — D113 Supervision module, battery lead (if required by local AHJ)	8 — To control panel SDI2 wiring
2 — Batteries	9 — D192G Notification appliance module
3 — D122/D122L Dual Battery Harness, as required	10 — To OUTPUT A (1) or OUTPUT B (2)
4 — To supervision point	11 — 560 Ω, 2 W EOL resistor (P/N: 15-03130-005)
5 —Transformer	12 — Listed audible signaling devices rated at 12.0 VDC nominal (do not use vibrating type horns)
6 — B520 Auxiliary Power Supply Module	13 — To earth ground
7 — To powered devices	

7.2 Input points wiring with D125B, D130, or D129

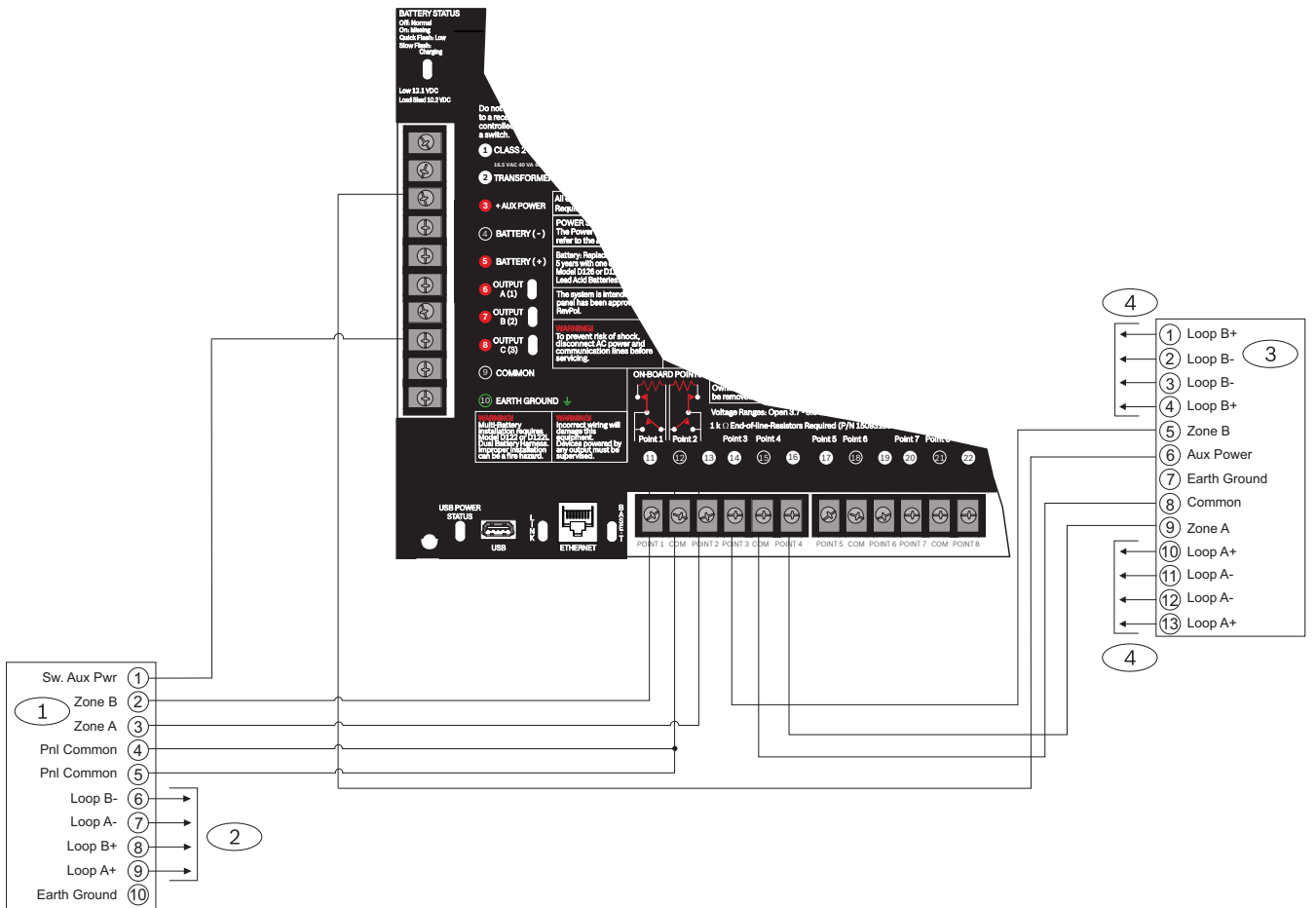

Figure 7.1: Input wiring with a D125B and a D129

Callout	Description
1	D125B Dual Class B Initiating Module
2	To compatible UL listed two-wire smoke detectors. Refer to the <i>D125B Installation Instructions</i> for a listing of compatible two-wire smoke detectors.
3	D129 Dual Class A Initiation Circuit Module
4	For wiring instructions, refer to the <i>D129 Dual Class A Initiation Circuit Module Installation Instructions</i> .



Notice!

Use zero retard except for waterflow devices.
 All external connections except Terminal 5 (battery positive) are power limited.
 Optionally, for 24 V applications use a UL 1481 listed, regulated, power-limited 24 VDC power supply with a D130 Relay Module. Refer to the *D130 Installation Instructions* for correct wiring requirements.

7.3 Input points wiring with or without EOL resistors



Notice!

EOL resistors

For the dual EOL resistor circuit style order ICP-1K22AWG-10, package of 10 1.0 kΩ EOL resistors.

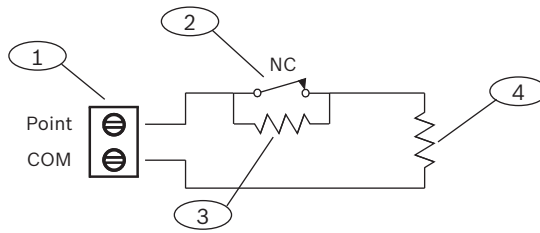

Callout - Description
1 - Point sensor loop terminals
2 - Normally closed device (contact)
3 - 1.0 kΩ resistor at device
4 - 1.0 kΩ resistor at EOL (end-of-line)

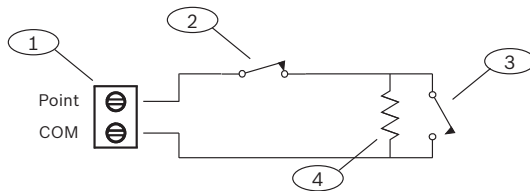

Figure 7.2: Single EOL (NC or NO)

Callout - Description
1 - Point sensor loop terminals
2 - Normally closed device (contact)
3 - Normally open device (contact)
4 - EOL Resistor – 1.0 kΩ (2.0 kΩ and No EOL optional)



Notice!

The No EOL option does not support the use of NO and NC contacts simultaneously.

7.4 SDI and ZONEX wiring



Notice!

Install Fire and Intrusion devices only on separate circuits. Refer to the *ICP-SDI-9114 Installation Instructions*.

All external connections except Terminal 5 (battery positive) are power limited.

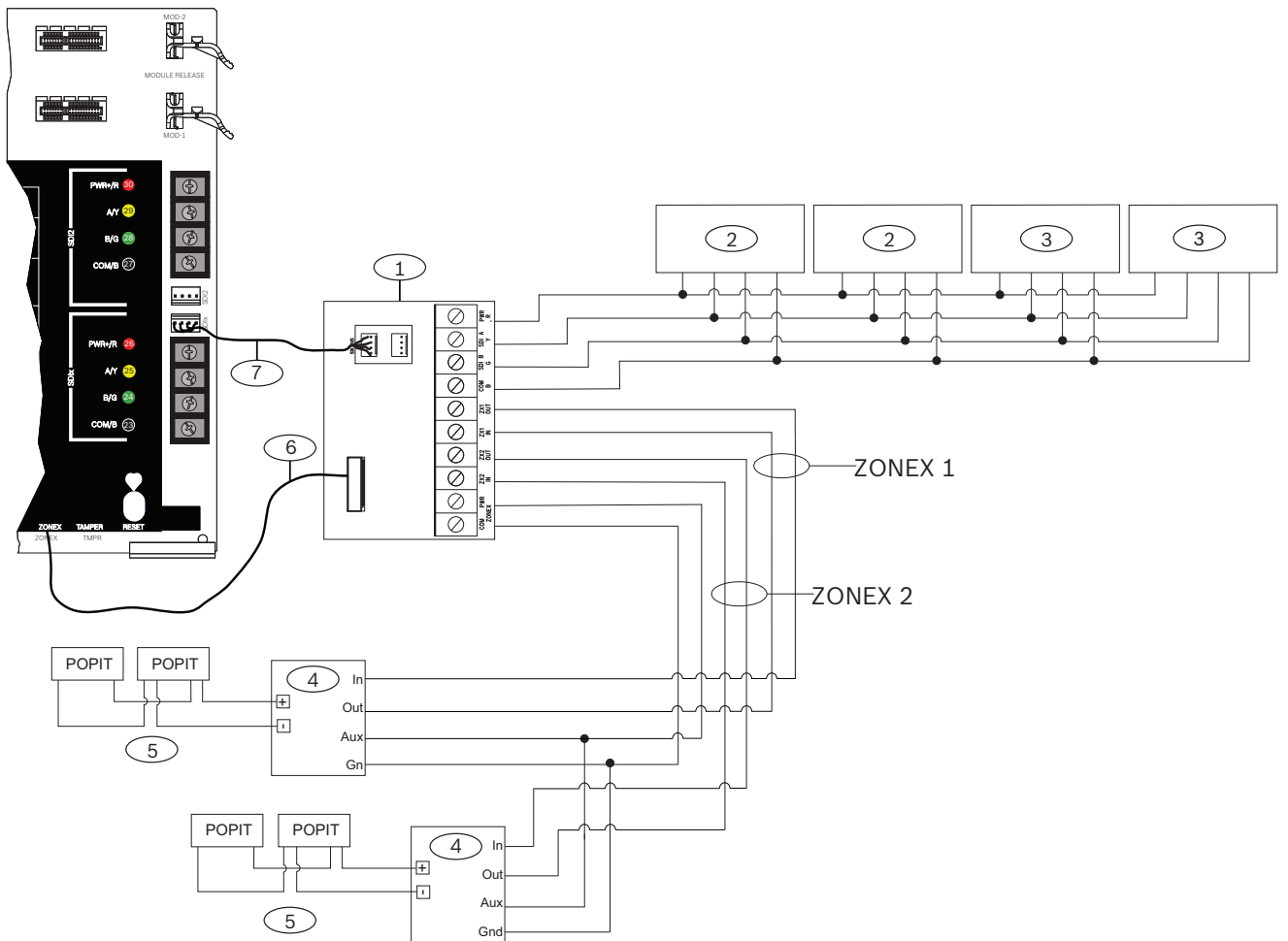

Callout — Description	Callout — Description
1 — B600	5 —Up to 119 D9127U/T POPITs
2 — SDI keypads when configuring SDIx for SDI (refer to System power/size)	6 — ZONEX connection cable (P/N: F01U295103) (included)
3 — Up to 8 D9210C Access Control Interface Modules	7 — Interconnect cable (P/N: F01U079745) (included)
4 — D8125 POPEX Modules	

*The number of D8129 Octo-relay modules allowed for each ZONEX terminal on the B600 is limited by the number of D8128D OctoPOPITs connected to the same terminal. Refer to the *D8128D Installation Guide* or the *D8129 Operation and Installation Guide* for detailed instructions.

7.5 SDI2 devices general system wiring

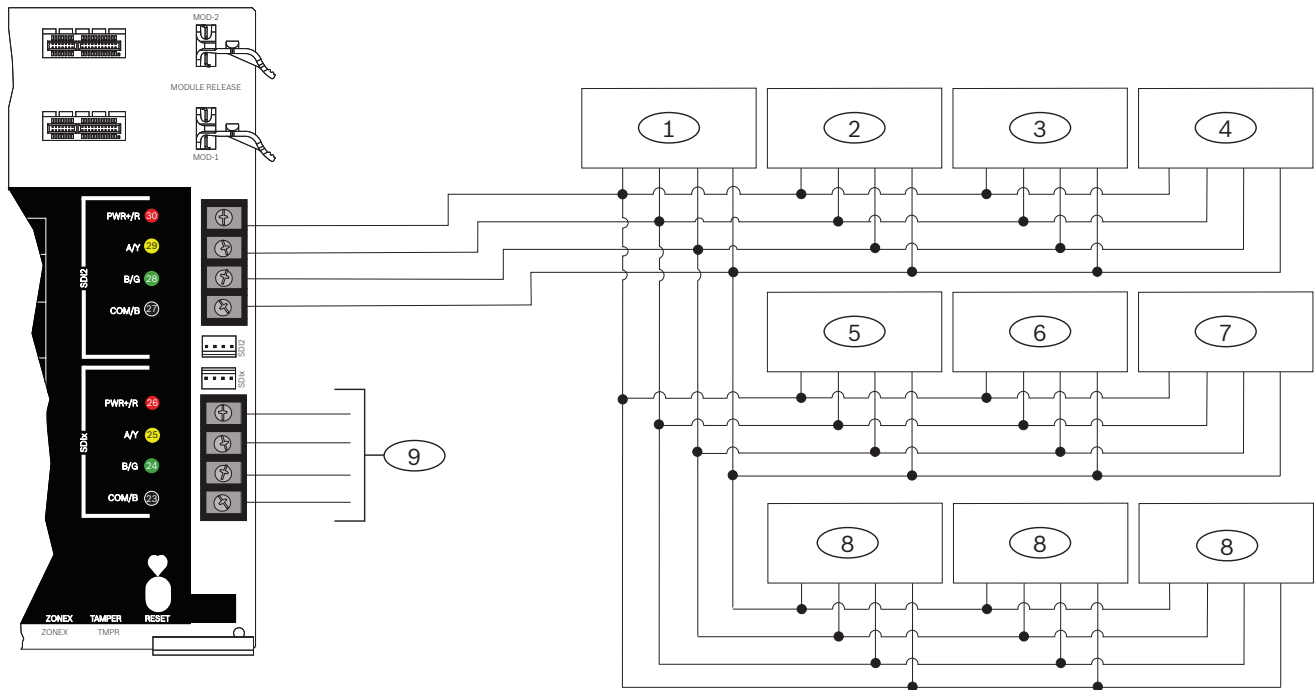

Callout — Description	B9512G/B9512G-E Capacity	B8512G/B8512G-E Capacity
1 — B208	59	9
2 — B299	6	1
3 — B308	59	9
4 — B426 or B450	2	2
5 — B520	8	4
6 — B810 or B820	1	1
7 — B901	32	8
8 — SDI2 keypads	32	16
9 — Configurable for SDI keypads and access control interface modules, or SDI2 devices		



Notice!

Each SDI2 bus supports up to 99 devices.
 The SDI2 power terminal (PWR+/R) is power limited. The SDI2 terminals are supervised.

7.5.1

SDI2 bus wiring recommendations

Use the following SDI2 bus wiring recommendations for SDI2 installation. The control panel and SDI2 modules use the SDI2 bus to communicate with one another.

You can wire modules via home run, daisy chain, or single level T-tap anywhere on the SDI2 bus.

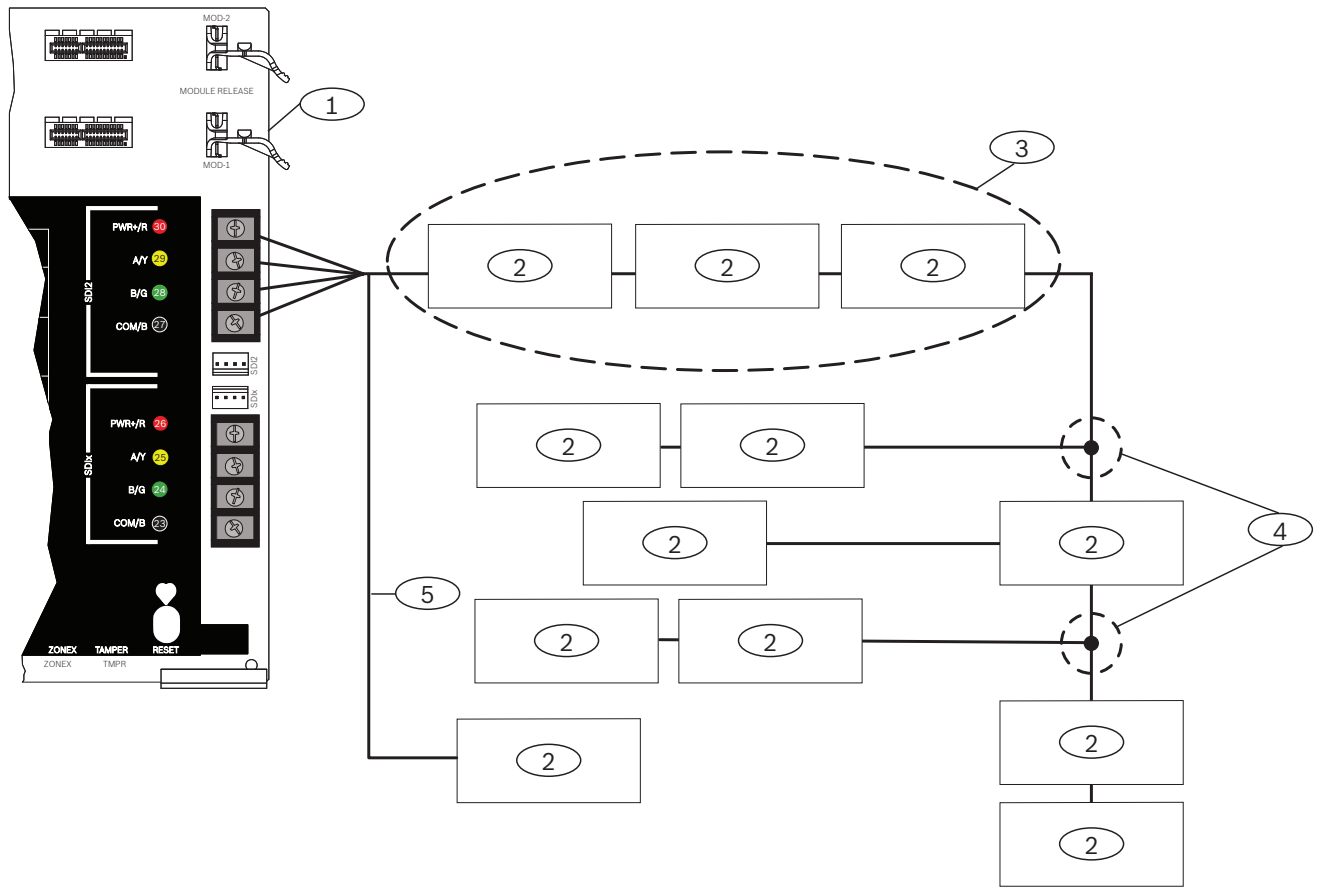

Callout — Description
1 — Control panel
2 — SDI2 device (module or keypad)
3 — Daisy chain wiring
4 — Single-level T-tapped wiring
5 — Home run wiring



Notice!

There can only be a difference of 2 volts (maximum) between the AUX power terminals of the control panel or power supply and the device for the modules and keypads to work properly under all conditions.

Maximum cable lengths

Follow these rules when wiring the SDI2 bus:

- The SDI2 bus requires the use of **unshielded** cable from 12 AWG to 22 AWG (0.65 mm to 2 mm).
- Refer to the SDI2 device or keypad documentation for the allowable maximum distance from the control panel.
- Maximum overall cable lengths are listed in the following table:

Cable capacitance	Overall cable length		Cable capacitance	Overall cable length	
	ft	m		ft	m
< 17	7500	2286	27	5185	1580
18	7500	2286	28	5000	1524
19	7350	2240	29	4828	1472
20	7000	2134	30	4700	1433
21	6666	2032	31	4516	1376
22	6363	1939	32	4400	1341
23	6086	1855	33	4242	1293
24	5800	1768	34	4100	1250
25	5600	1707	35	4000	1219
26	5385	1641	36	3800	1158

Table 7.1: Maximum cable length



Notice!

Use unshielded cable only.

Maximum capacitance of 140nF (140,000 pF) per system. Contact the wire manufacturer for the capacitance ratings of the wire being used.

7.6 2-wire smoke wiring (D125B)

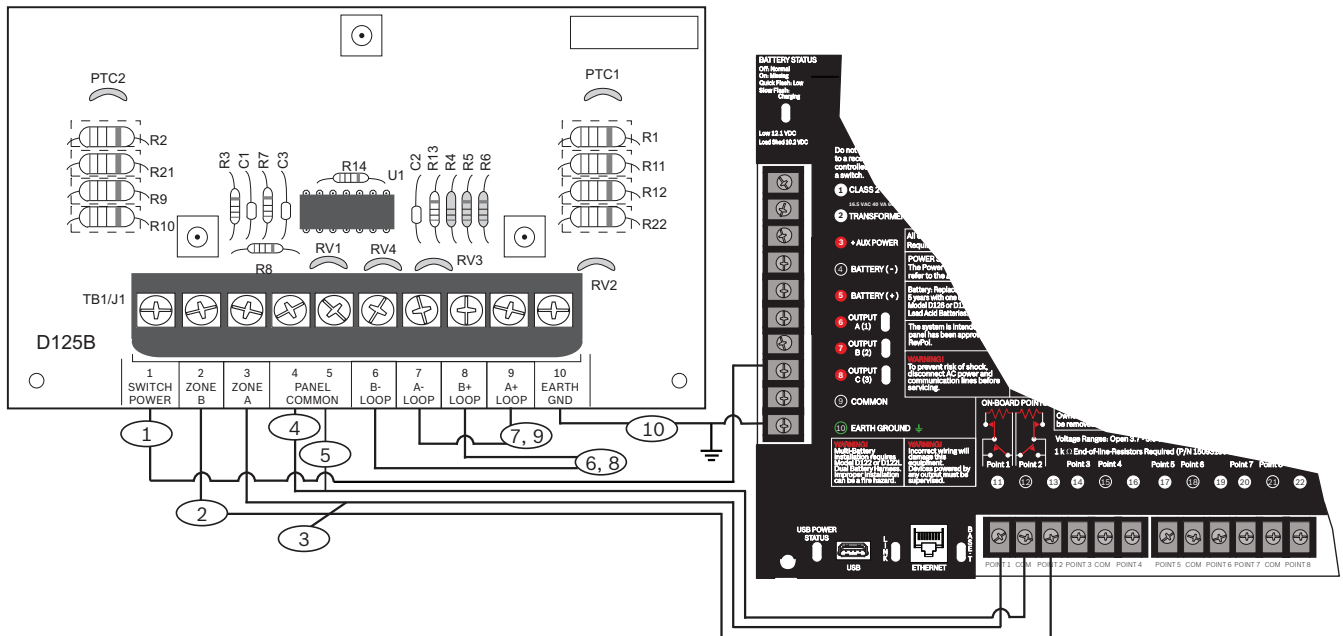

Callout — Description	Callout — Description
1 — Switched auxiliary power from relay C of the control panel	6 — Supervised smoke detector to B LOOP negative
2 — Supervised connection to Zone B power from an on-board point of the control panel	7 — Supervised smoke detector to A LOOP negative

Callout — Description	Callout — Description
3 — Supervised connection to Zone A power from an on-board point of the panel	8 — Supervised smoke detector to B LOOP positive
4/5 — Connection to common the control panel (one connection only)	9 — Supervised smoke detector to A LOOP positive

7.7 Earth ground wiring

To help prevent damage from electrostatic discharges or other transient electrical surges, connect the system to earth ground before making other connections. The \perp icon shows the earth ground terminal. Use a recommended earth ground reference, such as a grounding rod or a cold water pipe. Make the connection using 14 AWG (1.8 mm) to 16 AWG (1.5 mm) wire.



Notice!

Do not use telephone or electrical ground

Do not use telephone or electrical ground for the earth ground connection. Do not connect other control panel terminals to earth ground.



Caution!

Avoid electrostatic discharge

Always touch the earth ground connection with the \perp icon first, before beginning work on the control panel.

7.7.1 Ground Fault Detect enable

To meet UL 864 requirements, enable Ground Fault Detect.

A ground fault is a circuit impedance to ground sufficient to result in the annunciation of a trouble condition.

The control panel has a ground fault detection circuit that when enabled, detects ground faults on Terminals 1 to 9 and 11 to 30.

If a ground fault condition occurs, the keypads annunciate a ground fault and control panel transmits a trouble message.

When the control panel recognizes that the ground fault condition is corrected, and remains corrected for between 5 to 45 consecutive seconds, the control panel clears the fault from the keypad display and sends a restoral report.

The control panel detects ground fault at $\leq 300 \Omega$.

Enabling Ground Fault Detect and reports

- ▶ In RPS or in the Installer Services Portal programming tool (available in Europe, Middle East, Africa, and China), set the following parameters:
 - PANEL WIDE PARAMETERS > Miscellaneous > Ground Fault Detection. Set to Enable.
 - PANEL WIDE PARAMETERS > Report Routing > Burglar Reports > Trouble Report. Set to Yes.
 - PANEL WIDE PARAMETERS > Report Routing > Burglar Reports > Burg Restore (After Trouble). Set to Yes.

7.7.2 Ground fault detection troubleshooting

The control panel requires -2.1 V decay to 0.

Measuring and comparing voltage for ground fault detection

1. Set your digital voltmeter (DVM) to measure VDC.
2. Connect the red DVM lead to control panel Terminal 10, and the black DVM lead to Terminal 9.

3. Compare this voltage to the following table.

Control panel voltage at Terminals 9 and 10)	Terminal potentially causing ground fault
~ 0 VDC	4, 9, 12, 15, 17, 21
~ 13.65 VDC	5, 6, 7, 8, 26, 30
~ 2.51 VDC	11, 13, 14, 16, 17, 19, 20, 22
~ 2.44 to 3.2 VDC	24
~ 10.9 to 11.2 VDC	25
~ 7.2 VDC	28
~ 5.8VDC	29
~ 7.35 VDC	1, 2

8 B925F Fire Keypad operating instructions

This keypad is a full-function system controller and annunciator. The illuminated keypad has a display and a sounder that emits distinct condition tones to alert you to fire alarm, fire trouble, or fire supervisory events as they occur. In conjunction with the display and sounder, seven status indicators provide the following system status information as described below.

Required: Mount this document in view of the fire keypad.

Local Service Representative

Name _____

Address _____

Phone _____

Overview

Status indicators
The Status indicators provide a quick visual reference of the system status.

- Ready to arm** ✓
Lights when the system is ready to turn on (arm).
- On (armed)** 🔒
Lights when the system is on (armed).
- Gas** GAS
Lights when a gas alarm exists.
- Power** ⚡
Lights to indicate the control panel has AC power.

Fire function keys
ACK. Press to acknowledge the system alarm or trouble condition.
SILENCE. Press to silence fire alarm or trouble.
RESET. Press to reset devices such as smoke detectors.
DRILL. Press and hold to initiate fire drill.

Navigation and number keys
The keypad includes keys for navigating and entering passcodes:
PREV and NEXT. Use to scroll through menus or menu selections.
ENTER. Use to complete the entry of your passcode or other numbers, or to answer Yes to a keypad request.
backspace when you enter names and numbers.
ESC. Use to exit from menus and functions, or use as a backspace when you enter names and numbers.
Number keys. Use to enter passcodes or other numbers and letters.

Fire Status indicators
The Fire Status indicators provide a quick visual reference of the fire system status.

- Fire** 🔥
Lights when a fire alarm condition exists; turns off when all fire alarm points return to normal.
- Silenced** 🔔
Lights when a fire alarm condition is silenced; turns off when a user presses the RESET button or if another fire alarm condition appears.
- Supervisory** ⦿
Lights when any point programmed as supervisory is not normal; turns off when all supervisory points return to normal.
- Trouble** ⚠️
Lights when a trouble condition exists.

Intrusion function keys
ALL. Press to turn the system All On.
PART. Press to turn the system Part On.
BYPASS. Press to open the menu to bypass points.
MENU. Press to open the keypad's Main menu.

Operation

Normal operation

When in normal operation and off (disarmed), the keypad shows programmed idle text, such as *Fire System*, or System Ready.

Fire Alarm operation

When a fire alarm occurs, the Fire indicator lights, and the keypad emits a pulsing high-pitched fire tone (______). The tone sounds for the duration set by your security company. The keypad shows the first point that entered alarm and its area. Press ACK to acknowledge the alarm. The keypad shows the next point in alarm, if applicable. Press SILENCE to silence the alarm.

Fire Trouble operation

When a trouble condition occurs (such as wiring for a point is cut or AC power fails), the keypad sounder activates briefly approximately every six seconds. The Trouble indicator lights and the keypad shows the highest priority trouble. Press ACK to acknowledge the trouble. To view and acknowledge additional system or point troubles, press NEXT repeatedly.

Fire Supervisory operation

When a supervisory condition occurs, the sounder activates briefly approximately every six seconds. The Supervisory indicator lights and the keypad shows a fire supervisory message. Press ACK to acknowledge the supervisory condition. To view and acknowledge point supervisory conditions, press NEXT repeatedly.

Silence and reset

Alarm or Trouble silence. Press SILENCE and enter your passcode.
Detector reset. Press RESET and enter your passcode (if required). You can also use [CMD][4][7], or the Menu to reset detectors.

9 B926F Fire Keypad operating instructions

This keypad is a full-function system controller and annunciator. The illuminated keypad has a display and a sounder that emits distinct condition tones to alert you to fire alarm, fire trouble, or fire supervisory events as they occur. In conjunction with the display and sounder, seven status indicators provide the following system status information as described below.

Required: Mount this document in view of the fire keypad.

Local Service Representative

Name _____

Address _____

Phone _____

Overview

Status indicators
The Status indicators provide a quick visual reference of the system status.

- Ready to arm** ✓
Lights when the system is ready to turn on (arm).
- On (armed)** 🔒
Lights when the system is on (armed).

- Gas** GAS
Lights when a gas alarm exists.
- Power** ⚡
Lights to indicate the control panel has AC power.

Alphanumeric display

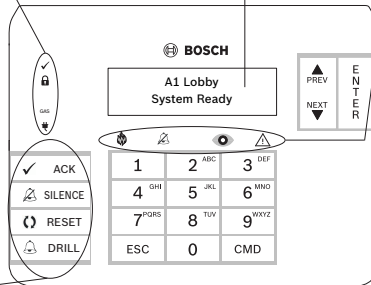

Fire Status indicators

The Fire Status indicators provide a quick visual reference of the fire system status.

- Fire** 🔥
Lights when a fire alarm condition exists; turns off when all fire alarm points return to normal.
- Silenced** 🔔
Lights when a fire alarm condition is silenced; turns off when a user presses the RESET button or if another fire alarm condition appears.
- Supervisory** 👁️
Lights when any point programmed as supervisory is not normal; turns off when all supervisory points return to normal.
- Trouble** ⚠️
Lights when a trouble condition exists.

Fire function keys

- ACK. Press to acknowledge the system alarm or trouble condition.
- SILENCE. Press to silence fire alarm or trouble.
- RESET. Press to reset devices such as smoke detectors.
- DRILL. Press and hold to initiate fire drill.

Navigation and number keys

- The keypad includes keys for navigating and entering passcodes: PREVIOUS and NEXT. Use to scroll through menus or menu selections.
- ENTER. Use to complete the entry of your passcode or other numbers, or to answer Yes to a keypad request.
- backspace when you enter names and numbers.
- ESC. Use to exit from menus and functions, or use as a backspace when you enter names and numbers.
- Number keys. Use to enter passcodes or other numbers and letters.

Operation

Normal operation

When in normal operation and off (disarmed), the keypad shows programmed idle text, such as *Fire System*, or System Ready.

Fire Alarm operation

When a fire alarm occurs, the Fire indicator lights, and the keypad emits a pulsing high-pitched fire tone (______). The tone sounds for the duration set by your security company. The keypad shows the first point that entered alarm and its area. Press ACK to acknowledge the alarm. The keypad shows the next point in alarm, if applicable. Press SILENCE to silence the alarm.

Fire Trouble operation

When a trouble condition occurs (such as wiring for a point is cut or AC power fails), the keypad sounder activates briefly approximately every six seconds. The Trouble indicator lights and the keypad shows the highest priority trouble. Press ACK to acknowledge the trouble. To view and acknowledge additional system or point troubles, press NEXT repeatedly.

Fire Supervisory operation

When a supervisory condition occurs, the sounder activates briefly approximately every six seconds. The Supervisory indicator lights and the keypad shows a fire supervisory message. Press ACK to acknowledge the supervisory condition. To view and acknowledge point supervisory conditions, press NEXT repeatedly.

Silence and reset

Alarm or Trouble silence. Press SILENCE and enter your passcode.
Detector reset. Press RESET and enter your passcode (if required). You can also use [CMD][4][7], or the Menu to reset detectors.

10 D1255RB operating instructions

This keypad is a system controller and annunciator. The illuminated keypad has a 16-character vacuum fluorescent display (VFD) and a sounder that emits distinct condition tones to alert you to fire alarm, fire trouble, or fire supervisory events as they occur. In conjunction with the VFD and the sounder, four status LEDs provide the following system status indications: Fire, Silenced, Supervisory, and Trouble.

Required: Mount this document in view of the fire keypad.

Local Service Representative	
Name	_____
Address	_____
Phone	_____

Overview

Status indicators

The Status indicators provide a quick visual reference of the system status.
Fire: Lights when a fire alarm condition exists; turns off when all fire alarm points return to normal.
Silenced: Lights after a fire alarm is silenced; turns off when a PIN and ESC is entered. This clears the alarm or trouble memory from the keypad display, when all points are in a normal state.
Supervisory: Lights when any point programmed as supervisory is not normal; turns off when all supervisory points return to normal.
Trouble: Lights when any system trouble or point trouble exists; turns off when the system and all points return to normal.

Alphanumeric display

Built-in sounder

The built-in sounder emits the following warning tones:
Fire signal: pulsed, high-pitched bell tone during fire alarm.
Trouble signal: two-tone warble during a trouble event.
Invalid key buzz: buzz tone when invalid key is pressed.
Keypad encoding tone: muted beep tone as each key is pressed.

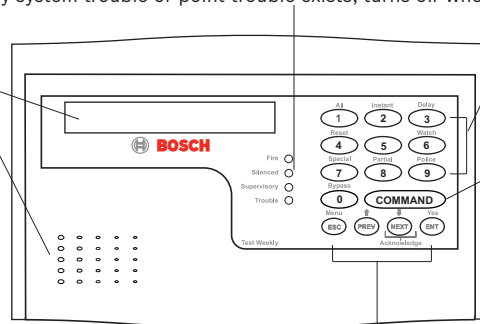

Number keys

Use one or two in combination with the COMMAND bar to perform a function, or use to enter a PIN before pressing the ENT key.

COMMAND bar

Use in combination with one or two numeric keys to perform a function.

Navigation keys

Use ESC/Menu to enter the command menu, to complete a command entry, or to return to idle text.
 Use PREV to return to the previously viewed menu item.
 Use NEXT/Acknowledge to acknowledge an alarm or off-normal condition, or to move to the next menu item.
 Use ENT/Yes to complete a PIN entry, or to select a menu item.

Operation

Normal operation

When the system is operating normally and is disarmed, the display shows the programmed idle text. The default system normal message is * FIRE SYSTEM *.

Fire Alarm operation

When an alarm occurs, the Fire LED activates, and the keypad emits a pulsing high-pitched fire tone. The tone sounds for a pre-programmed length of time. A display message appears that describes the first point that entered an alarm. Press the NEXT key to acknowledge the alarm. To view and acknowledge additional points that are in alarm, press NEXT repeatedly. The display shows Ax ## FIRE ALARM (x = the area number; ## = the number of fire alarms in Area x).

Fire Trouble operation

When a trouble condition occurs (such as wiring for a point is cut, AC power fails, and so on), the keypad sounder activates briefly approximately every six seconds. The Trouble LED illuminates and Ax ## FIRE TRBL or the highest priority system trouble appears in the display. Press the NEXT key to acknowledge the trouble. To view and acknowledge additional system or point troubles, press NEXT repeatedly.

Fire Supervisory operation

Fire Supervisory Operation. When a supervisory condition occurs, the sounder activates briefly approximately every six seconds. The Supervisory LED illuminates and Ax ## FIRE SUPV appears in the display. Press the NEXT key to acknowledge the supervisory condition. To view and acknowledge point supervisory conditions, press NEXT repeatedly.

Silence and reset

Alarm silence. Enter PIN (if required) and press ENT.
Trouble silence. Press the COMMAND bar and select 4.
Detector reset. Press the COMMAND bar and select 4 + 7.
Annunciating reset. Enter PIN (if required) and press ESC. This clears alarm or trouble memory from the keypad display, when all points are in a normal state.

11 D1256RB operating instructions

This keypad is a system controller and annunciator. The illuminated keypad has a 16-character vacuum fluorescent display (VFD) and a sounder that emits distinct condition tones to alert you to fire alarm, fire trouble, or fire supervisory events as they occur. In conjunction with the VFD and the sounder, four status LEDs provide the following system status indications: Fire, Silenced, Supervisory, and Trouble.

Required: Mount this document in view of the fire keypad.

Local Service Representative

Name _____
 Address _____

 Phone _____

Overview

Status indicators

The Status indicators provide a quick visual reference of the system status.

Fire: Lights when a fire alarm condition exists; turns off when all fire alarm points return to normal.

Silenced: Lights after a fire alarm is silenced; turns off when a PIN and ESC is entered. This clears the alarm or trouble memory from the keypad display, when all points are in a normal state.

Supervisory: Lights when any point programmed as supervisory is not normal; turns off when all supervisory points return to normal.

Trouble: Lights when any system trouble or point trouble exists; turns off when the system and all points return to normal.

Alphanumeric display

Built-in sounder

The built-in sounder emits the following warning tones:
 Fire signal. Pulsed, high-pitched bell tone during fire alarm.
 Trouble signal. Two-tone warble during a trouble event.
 Invalid key buzz. Buzz tone when invalid key is pressed.
 Keypad encoding tone. Muted beep tone as each key is pressed.

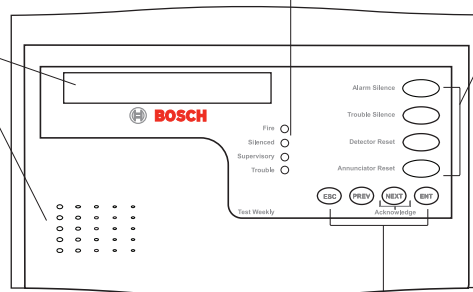

Function keys

Use one or two in combination with the COMMAND bar to perform a function, or use to enter a PIN before pressing the ENT key.

Navigation keys

Use ESC/Menu to enter the command menu, to complete a command entry, or to return to idle text.

Use PREV to return to the previously viewed menu item.

Use NEXT/Acknowledge to acknowledge an alarm or off-normal condition, or to move to the next menu item.

Use ENT to complete a PIN entry, or to select a menu item.

Operation

Normal operation

When the system is operating normally and is disarmed, the display shows the programmed idle text. The default system normal message is * FIRE SYSTEM *.

Fire Alarm operation

When an alarm occurs, the Fire LED activates, and the keypad emits a pulsing high-pitched fire tone. The tone sounds for a pre-programmed length of time. A display message appears that describes the first point that entered an alarm. Press the NEXT key to acknowledge the alarm. To view and acknowledge additional points that are in alarm, press NEXT repeatedly. The display shows Ax ## FIRE ALARM (x = the area number; ## = the number of fire alarms in Area x).

Fire Trouble operation

When a trouble condition occurs (such as wiring for a point is cut, AC power fails, and so on), the keypad sounder activates briefly approximately every six seconds. The Trouble LED illuminates and Ax ## FIRE TRBL or the highest priority system trouble appears in the display. Press the NEXT key to acknowledge the trouble. To view and acknowledge additional system or point troubles, press NEXT repeatedly.

Fire Supervisory operation

Fire Supervisory Operation. When a supervisory condition occurs, the sounder activates briefly approximately every six seconds. The Supervisory LED illuminates and Ax ## FIRE SUPV appears in the display. Press the NEXT key to acknowledge the supervisory condition. To view and acknowledge point supervisory conditions, press NEXT repeatedly.

Silence and reset

Alarm silence. Press the Alarm Silence key to silence a fire alarm.

Trouble silence. Press the Trouble Silence key to silence a fire trouble.

Detector reset. Press the Detector Reset key to reset detection devices.

Annunciating reset. Press the Annunciator Reset key to clear all alarm, trouble, and supervisory messages when all points are in a normal state.

12 Specifications

Control panel power supply specifications

Voltage input (power supply)	Primary	Terminals 1 and 2	16.5 VAC 40 VA class 2 plug-in transformer (D1640)
	Secondary	Terminals 4 and 5	Use 12 VDC sealed lead-acid rechargeable battery (7 Ah, 18 Ah, or 38 Ah). The control panel supports up to 38 Ah of battery. If you use two batteries, they must have the same capacity and you must connect them using the D122/D122L.
Current requirements	Control Panel: Idle 190 mA; Alarm 265 mA Refer to the <i>Current Rating Chart for Standby Battery Calculations</i> section in the <i>Control Panels (B9512G/B8512G) Installation and System Reference Guide</i> for the current draw requirements of other system components.		
Power outputs	All external connections are power-limited except battery terminals.		
	Continuous Power Outputs	1.4 A maximum at 12.0 VDC nominal (continuous supply) total for all devices and outputs including the ZONEX connection, the plug-in module connector, and Terminals 3, 26, and 30.	
	Alarm Power Output	2.0 A maximum (1.4 A max for commercial fire) at 12.0 VDC nominal output for all devices and outputs including the ZONEX connection, the plug-in module connector, and Terminals 3, 6, 7, 26, and 30. Output can be steady or one of three pulsed patterns depending on programming. Refer to <i>Relays</i> in the <i>RPS Help</i> or in the Installer Services Portal programming tool (available in Europe, Middle East, Africa, and China) <i>Help</i> .	
	Switched Aux Power	Terminal 8	1.4 A maximum at 12.0 VDC nominal output. Continuous output is interrupted by Sensor Reset or alarm verification depending on programming. Refer to <i>Relays</i> in the <i>RPS Help</i> , in the Installer Services Portal programming tool (available in Europe, Middle East, Africa, and China) <i>Help</i> , or in the <i>Control Panels (B9512G/B8512G) Program Entry Guide</i> .
Fire and Fire/Burglary Systems	To comply with UL 985 and 864 listing standards for fire alarm systems (effective March 1, 1989), the total combined continuous and alarm current draw for the system during alarm conditions must be limited to 1.4 A provided by the primary power supply (rectified AC). If current draw for the system exceeds 1.4 A, remove connected devices until the current draw falls below 1.4 A. Then, connect the removed devices to an external power supply ¹ (such as B520).		
¹ Requires a UL Listed power supply.			
Minimum operating voltage	10.2 VDC		
SDI bus	SDI bus A: SDI bus B:	9 VDC 4572 m (15000 ft) maximum 9 VDC 4572 m (15000 ft) maximum	
SDI2 bus	SDI2 bus A:	12 VDC nominal (7500 ft) maximum ²	

	SDI2 bus B:	12 VDC nominal (7500 ft) maximum ²
Network	Built-in 10/100 Ethernet LAN (RJ-45 connector)	
USB	USB 2.0 full speed	
Environmental	Temperature:	0°C to +49°C (+32°F to +120°F)
	Relative Humidity:	Maximum 93% non-condensing
Arming stations	B940W, B942/B942W, B930, B921C, B920, B915/B915I, D1260, D1257/D1257RB, D1256/D1256RB, D1255/D1255R/D1255RB, Keyswitch	
Point thresholds (Single EOL resistor circuit style) On-board points 1 to 8	With 1.0 kΩ resistors	Open - 3.7 to 5.0 VDC Normal - 2.0 to 3.0 VDC Short - 0.0 to 1.3 VDC Short circuit current - 5 mA
	With 2.0 kΩ resistors	Open - 4.1 to 5.0 VDC Normal - 3.0 to 4.1 VDC Short - 0.0 to 3.0 VDC Short circuit current - 5 mA
	No EOL	Open - 2.6 to 5.0 VDC Short - 0.0 to 2.4 VDC Short circuit current - 5 mA
Point thresholds (Dual EOL on-board points)	Dual EOL (1.0 kΩ + 1.0 kΩ)	Short - 0 to 1.67 VDC Open - 4.12 to 4.95 VDC Normal - 1.69 to 2.94 VDC Fault - 2.95 to 4.10 VDC Short circuit current - 5 mA
Compatible enclosures	B8103 Universal Enclosure, D8103 Universal Enclosure, D8109 Fire Enclosure, D8108A Attack Resistant Enclosure, BATB-40 and BATB-80 Battery Boxes.	

12.1 Wire requirements

Terminal label	Terminal description	Requirements
1	AC	18 AWG to 14 AWG (1.02 mm to 1.8 mm)
2	AC	18 AWG to 14 AWG (1.02 mm to 1.8 mm)
3	+ AUX POWER	Terminal accommodates 22 AWG to 14 AWG (0.65 mm to 1.8 mm), use appropriate wire size based on current
4	BATTERY -	Bosch supplied wire lead, included with control panel.
5	BATTERY +	
6	Output A (1)	Terminal accommodates 22 AWG to 14 AWG (0.65 mm to 1.8 mm), use appropriate wire size based on current
7	Output B (2)	
8	Output C (3)	
9	COMMON	
10	EARTH GROUND	16 AWG to 14 AWG (1.5 mm to 1.8 mm)

11	POINT 1	Terminal accommodates 22 AWG to 14 AWG (0.65 mm to 1.8 mm), use appropriate wire size based on loop resistance less than 100 Ω
12	POINT 1/2 COMMON	Terminal accommodates 22 AWG to 14 AWG (0.65 mm to 1.8 mm), use appropriate wire size based on loop resistance less than 100 Ω
13	POINT 2	Terminal accommodates 22 AWG to 14 AWG (0.65 mm to 1.8 mm), use appropriate wire size based on loop resistance less than 100 Ω
14	POINT 3	Terminal accommodates 22 AWG to 14 AWG (0.65 mm to 1.8 mm), use appropriate wire size based on loop resistance less than 100 Ω
15	POINT 3/4 COMMON	Terminal accommodates 22 AWG to 14 AWG (0.65 mm to 1.8 mm), use appropriate wire size based on loop resistance less than 100 Ω
16	POINT 4	Terminal accommodates 22 AWG to 14 AWG (0.65 mm to 1.8 mm), use appropriate wire size based on loop resistance less than 100 Ω
17	POINT 5	Terminal accommodates 22 AWG to 14 AWG (0.65 mm to 1.8 mm), use appropriate wire size based on loop resistance less than 100 Ω
18	POINT 5/6 COMMON	Terminal accommodates 22 AWG to 14 AWG (0.65 mm to 1.8 mm), use appropriate wire size based on loop resistance less than 100 Ω
19	POINT 6	Terminal accommodates 22 AWG to 14 AWG (0.65 mm to 1.8 mm), use appropriate wire size based on loop resistance less than 100 Ω
20	POINT 7	Terminal accommodates 22 AWG to 14 AWG (0.65 mm to 1.8 mm), use appropriate wire size based on loop resistance less than 100 Ω
21	POINT 7/8 COMMON	Terminal accommodates 22 AWG to 14 AWG (0.65 mm to 1.8 mm), use appropriate wire size based on loop resistance less than 100 Ω
22	POINT 8	Terminal accommodates 22 AWG to 14 AWG (0.65 mm to 1.8 mm), use appropriate wire size based on loop resistance less than 100 Ω
ZONEX	ZONEX	Bosch supplied wire, included with the optional B600
23	SDIx COMMON	Terminal accommodates 22 AWG to 14 AWG (0.65 mm to 1.8 mm), use appropriate wire size based on peripheral device current
24	SDIx DATA BUS B	22 AWG to 14 AWG (0.65 mm to 1.8 mm)
25	SDIx DATA BUS A	

26	SDIx POWER	Terminal accommodates 22 AWG to 14 AWG (0.65 mm to 1.8 mm), use appropriate wire size based on peripheral device current
27	SDI2 COMMON	Terminal accommodates 22 AWG to 14 AWG (0.65 mm to 1.8 mm), use appropriate wire size based on peripheral device current
28	SDI2 DATA BUS B	22 AWG to 14 AWG (0.65 mm to 1.8 mm)
29	SDI2 DATA BUS A	
30	SDI2 POWER	Terminal accommodates 22 AWG to 14 AWG (0.65 mm to 1.8 mm), use appropriate wire size based on peripheral device current



Bosch Security Systems B.V.

Torenallee 49

5617 BA Eindhoven

Netherlands

www.boschsecurity.com

© Bosch Security Systems B.V., 2019